

TUMBLE DRYERS

SOMETIMES LESS CAN BE MORE

DD11 BASIC
DD16 BASIC

FEATURES

- Tumble dryer in galvanised steel.
- Big loading door (opening of 180°).
- Direct drive through a gearbox, no pulley.
- Time and temperature selection. (These models do not allow the moisture control option).
- REVERSING DRUM: All models offer the reverse turning of the drum.
- Drum in galvanised steel.
- Radial airflow circuit.
- New filter drawer with wide surface and improved airflow.
- Cool Down: Anti-wrinkle at the end of cycle.
- Models available in electric or gas heating.



OPTIONS

- Version in 60 Hz.
- Marine versions 440V III 60 Hz No neutral or 480V III 60 Hz No neutral.



Inversion de sens



Tambour efficace



Double flux
Axial & Radial



Sechage Doux

TECHNICAL DATA	UNIT.	DD11 BASIC	DD16 BASIC		
CAPACITY					
Capacity 1/18	Kg	12	18		
Capacity 1/20	Kg	11	17		
Hourly Output BASIC	Kg/h	21	33		
Evaporation capacity BASIC	l/h	10,9	17,2		
DRUM					
Ø Drum	mm	750	750		
Ø Door	mm	574	574		
Door center height	mm	976	976		
Load hole bottom height	mm	689	689		
Drum length	mm	475	746		
Drum volume	l	210	330		
POWER					
Drum motor power	Kw	0,25	0,25		
Fan Motor Power BASIC	Kw	0,25	0,25		
Total Installed power BASIC	Kw	12,55	18,55		
Electric Heating (Installed power)	Kw	12	18		
Gas heating (installed Power) in KW	Kw	20,51	20,51		
Gas heating (installed el. power) BASIC	Kw	0,55	0,55		
CONNECTIONS					
		ELECTRICAL	GAS	ELECTRICAL	GAS
Tension 230V - I + T	N° x mm2 / A	3 x 35 / 63A	3 x 1,5 / 20A	-	3 x 1,5 / 20A
Tension 230V - III + T	N° x mm2 / A	4 x 10 / 40A	4 x 1,5 / 20A	4 x 16 / 63A	4 x 1,5 / 20A
Tension 400V - III + N + T	N° x mm2 / A	5 x 4 / 25A	5 x 1,5 / 20A	5 x 10 / 32A	5 x 1,5 / 20A
Ø Gas inlet	BSP	1/2"		1/2"	
DIMENSIONS / PACKING DIMENSIONS					
Width / Width	mm	785 / 865		785 / 865	
Depth / Depth	mm	840 / 940		1.110 / 1.210	
Height / Height	mm	1.694 / 1.840		1.694 / 1.840	
Height without heating battery	mm	-		-	
Net weight / Gross weight	Kg	172 / 180		187 / 200	
OTHERS					
Max airflow BASIC	m3/h	850		850	
Ø Fume exhaust	mm	200		200	
Sound level BASIC	dB	64		64	

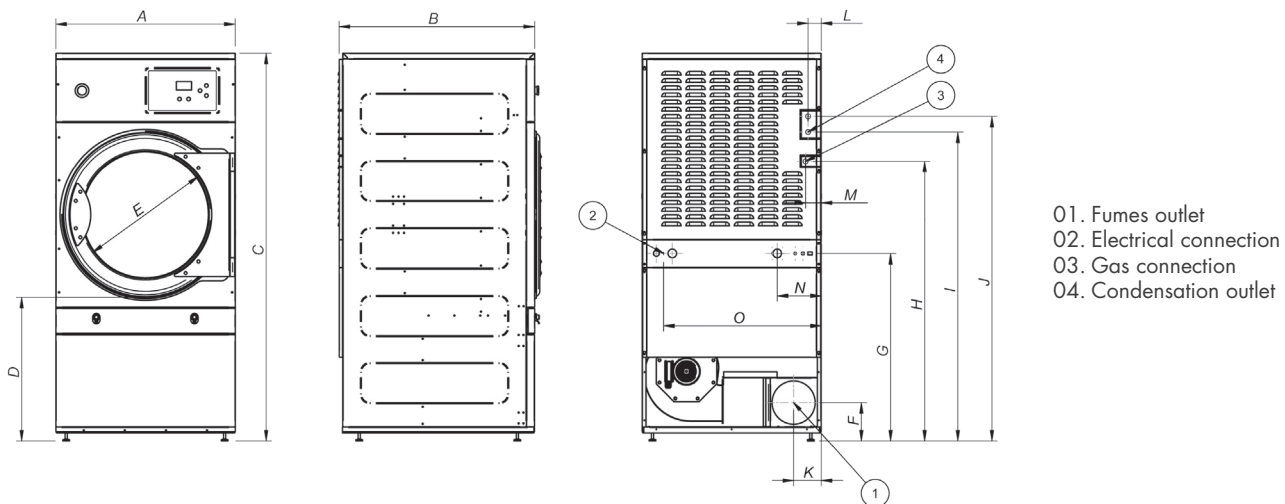

	A	B	C	D	E	F	G	H	I	J	K	L	M	N	O
DD11	785	840	1.700	618	574	168	821	1.226	1.354	1.422	121	56	68	192	690
DD16	785	1.010	1.700	618	574	168	821	1.226	1.354	1.422	121	56	68	192	690